

SIMPLE, RELIABLE AND EASY TO INSTALL

Technical manual

Mounting IMS-Solar on a corrugated roof.

CORRUGATED

STEEL

ROOF TILE

Simple, reliable and easy to install in 6 steps on a corrugated roof

- 1** Installing hanger bolts or corrugated brackets
- 2** Installing BP basic profiles
- 3** Mounting IP-fix
- 4** Click IP insert profiles
- 5** Click cable bracket and opti bracket
- 6** Insert solar panels

Index

1. General installation conditions	03	2. Parts overview	06
<ul style="list-style-type: none"> ■ General information ■ Stability and conditions of the roof ■ Safety warnings ■ Coverage of application in the Netherlands ■ Wind load ■ Standards, regulations and legislation ■ Removal and disassembly ■ Warranty ■ Liability 	<ul style="list-style-type: none"> 03 03 04 04 05 05 05 05 05 	<ul style="list-style-type: none"> 3. Installing IMS-Solar ■ Tools required ■ Installation ■ Step 1: Installing hanger bolts or corrugated brackets ■ Step 2: Mounting BP basic profiles ■ Step 3: Mounting IP-fix ■ Step 4: Click IP insert profiles ■ Step 5: Click cable bracket and opti bracket ■ Step 6: Insert solar panels 	<ul style="list-style-type: none"> 07 07 07 08 09 10 10 12 12



This extensive manual describes the installation of the mounting system for solar panels on a corrugated roof. Follow these instructions carefully and perform the actions in the correct order. If you lose the manual, you can always download it from www.ims-solar.com.

1. General installation conditions

General information

All information, data and advises from this manual are binding. IMS-Solar remains the right to revise the manual based at developments or experiences of everyone involved.

Should you not comply to the rules stated in this document may cause all warranty and product liability claims to become void.

Stability and conditions of the roof

It's important to check the conditions of the roof upfront. The roof should be in good condition and should have enough strength to bear the weight of the solar panels including additional materials. In addition, the roof must also meet the standards for wind and snow load. Please note that the load reserve of the roof is not exceeded anywhere. Check the stability of the roof and adjust if necessary. If in doubt, contact a specialist.

Safety warnings

- Installation should be carried out by qualified technical constructors.
- Before starting installation the roof should be clean, dry etc.
- Should installation take place at a slanted roof please make sure to use fall protection materials such as edge protection and safety nets.
- If the surface of the roof is slippery due to rain or there is a strong wind, please avoid installation!
- It is recommended to follow the drawings in detail. Omitting or adding parts at your discretion may negatively affect the functioning of the mounting system and is therefore strongly discouraged!
- Place rubber fuses at the top between the panels if the slope of the panels is less than 10 degrees. With less slope, the pressure underneath is less; this prevents movement.
- Always wear appropriate protective shoes and clothing.
- Always wear work gloves for protection. Also to avoid damage to the solar panels; don't hold them without gloves.

- Never stand in a gutter!
- Use a lifting aid/lift installation to move materials.
- Use of a ladder should always take place on a solid surface and should be placed at an angle of 75 degrees, about one meter sticking out above the roof edge. Secure the top of the ladder by using a rope or fastener if possible.
- Please make sure to be informed about the last developments by checking the most recent version of the manual and guarantees.

Coverage of application in the Netherlands

- Solar panels: of all brands and models with a frame height of 30 or 35 mm.
- Wind zones: 1 to 3, terrain category II en III (NEN 1991-1-4).
- Roof height: 3 - 15 m. Should the roof be higher please contact your supplier.
- Type of roof: corrugated roof.
- Slope of the roof: between 15 - 60 degrees (35 degrees will be optimal).

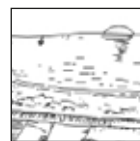

Terrain category 0

Sea or coastal area with winds coming over the open sea.



Terrain category II

Area with low vegetation such as grass and freestanding obstacles (trees, buildings) with a spacing of at least 20 obstacle heights.



Terrain category III

Area with regular vegetation or buildings or isolated obstacles with spacing of no more than 20 obstacle heights (such as villages, suburban terrain, permanent forest).

Windload

Due to the influence of the wind, the distance of the solar panels to the top and bottom of the roof is at least 30 cm. The same applies for the distance of the solar panels to both sides of the roof. Please do not place solar panels partly or entirely within this area! Also think about sufficient room to move for maintenance work.

Standards, regulations and legislation in the Netherlands

To prevent accidents it's important to follow the mounting manual and regulations. Please pay attention to the below norms, regulations and legislation.

- **NEN 7250:2014** Constructive aspects solar-energy systems
- **NEN-EN 1990** Basis of the constructive design
- **NEN-EN 1991-1-3** General weight: snow
- **NEN-EN 1991-1-4** General weight: wind
- **NEN 1010:2015** Electrical installations for low voltage (HD-IEC 60364)
- **NEN-EN-IEC 62305** Lightning protection
- **Arbowet en Arboregeling** Safety labour and social affairs
- **NEN 3140** Safety management low voltage installations
- **Checklist VCA** Safe operation at location
- **Regulations scaffolds and ladders**

Removal and disassembly

Removal of the products accordingly to local laws and regulations

Warranty

Warranty according to the general conditions of IMS-Solar BV can be found at www.ims-solar.com.

Liability

IMS-Solar BV shall not be held liable for any damage or injury caused by a failure to not (strictly) comply with our safety regulations and instructions in this manual or due to negligence during installation our product and/or any involved accessories.

2. Parts overview

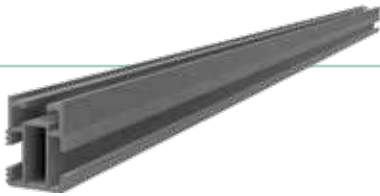

- **12031** BP basic profile 6m
Dimensions: 6000 x 36,7 x 30 mm



- **12032** BP basic profile black 6m
Dimensions: 6000 x 36,7 x 30 mm

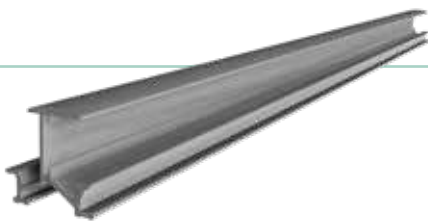

- **14031** IP-30 insert profile 6,2m
Dimensions: 6200 x 52,9 x 51,93 mm

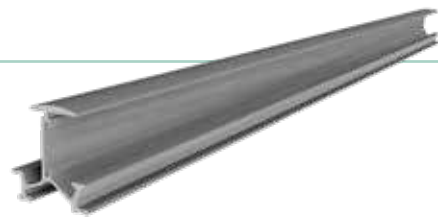

- **14051** IP-35 insert profile 6,2m
Dimensions: 6200 x 52,9 x 56,93 mm



- **14032** IP-30 insert profile black 6,2m
Dimensions: 6200 x 52,9 x 51,93 mm



- **14052** IP-35 insert profile black 6,2m
Dimensions: 6200 x 52,9 x 56,93 mm



- **14041** IP-30 insert profile light 6,2m
Dimensions: 6200 x 52,9 x 44,8 mm



- **14061** IP-35 insert profile light 6,2m
Dimensions: 6200 x 52,9 x 49,8 mm



- **14042** IP-30 insert profile light black 6,2m
Dimensions: 6200 x 52,9 x 44,8 mm



- **14062** IP-35 insert profile light black 6,2m
Dimensions: 6200 x 52,9 x 49,8 mm

- **21051**
IP-E insert profile end cap
- **21052**
IP-E insert profile end cap black

- **21061**
IP-C insert profile connector

- **60104**
Power ground clamp

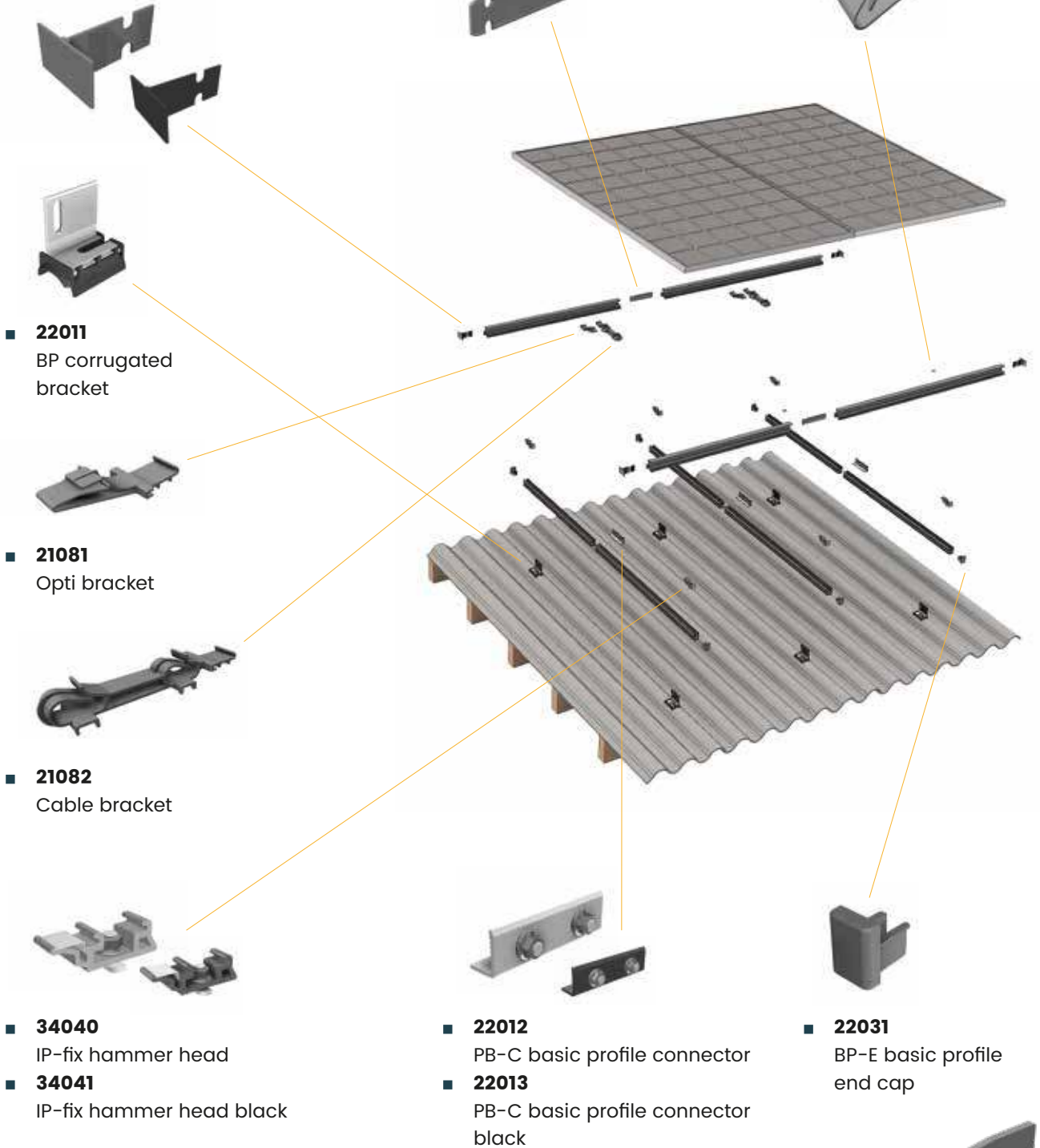

- **22011**
BP corrugated bracket

- **21081**
Opti bracket

- **21082**
Cable bracket

- **34040**
IP-fix hammer head
- **34041**
IP-fix hammer head black

- **22012**
PB-C basic profile connector
- **22013**
PB-C basic profile connector black

- **22031**
BP-E basic profile end cap

- **60101**
Use the IMS mounting tool for securing various parts. Make sure you use the right movement as described; upwards or downwards.



3. Installing IMS-Solar

Tools required



Drillmaster



IMS mounting tool



Pencil

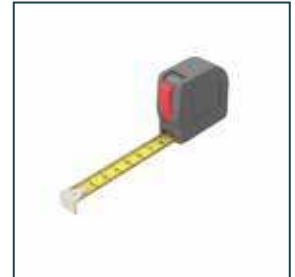

Measure tape

Installation

Before installing the mounting materials the roof needs to be cleaned with a brush. Remove algae, moss and debris to reduce unevenness during the installation. The position of the roof compared to the sun is essential to receive optimal results. Surrounding buildings or trees can create shade, which will have a negative effect on the result and efficiency of the solar panels. Therefore, check the surroundings in advance.

This manual is only suitable for corrugated roofs that are not made of corrugated steel.

The basic beam construction of the roof is used to support the corrugated sheets above and are made of wood or steel. In the latter situation, it is only possible to install the IMS-Solar mounting materials by using existing screw points.

There are two options for mounting the BP basic profiles on the roof; install hanger bolts or corrugated brackets. For both options it's recommended to use existing fixation points as much as possible.

Step 1. Installing hanger bolts or corrugated brackets

As indicated earlier, it is important that the distance of the solar panels to the top and bottom of the roof is at least 30 cm. The same applies for the distance of the solar panels to both sides of the roof.

Use existing fixation points as much as possible. Check the outcome of the IMS calculation program; the maximum distance between the fixation points plus the required amount is displayed. There are two options for mounting the BP basic profiles on the roof.



Option 1: Use a hanger bolt. Replace the existing bolt by the hanger bolt and mount the BP basic profile with a connector.

Option 2: Use a corrugated bracket. Loosen the existing screw bolt up at least 30 mm, then slide the corrugated bracket around the fixation from above. After the corrugated bracket has been correctly positioned, the existing screw is retightened to 3.5 Nm.

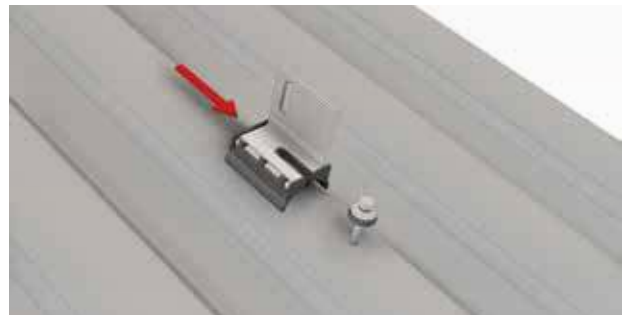

At new locations, a hole is drilled in the top of the wave in the right place. The pre-drilling diameter in the corrugated sheet must be larger than the diameter of the screw used. Place a screw bolt in the hole and slide the bracket around it from above. After it is properly positioned, it can be tightened up to 3.5 Nm.

Step 2. Installing BP basic profiles

Depending on which option you used (the hanger bolts or the corrugated brackets) the BP basic profiles can now be easily mounted.

Option 1: Attach the BP basic profile to the hanger bolt by using the connector. On the other side, use the hammer head bolt to secure the BP basic profile.

Option 2: Insert the hammer head bolts with the threads through the upright part of the corrugated brackets and place the head in the slot of the profile. Tighten the flare nut clockwise.



For both options it is important that the head of the bolt is properly placed in the slot and that the groove in the head is vertical.

If the installation is higher than 6 meters, the BP basic profiles need to be connected with the BP-C basic profile connector.



Once the right dimensions are installed you can finalize the top and bottom by adding the BP-E basic profile end caps. These are simply pushed into the header of the profile.



Step 3. Mounting IP-fix

In preparation it is important to determine the vertical positions of the IP-fix on the BP basic profile with the intermediate size of the solar panel + 14 mm (module size from hole to hole).

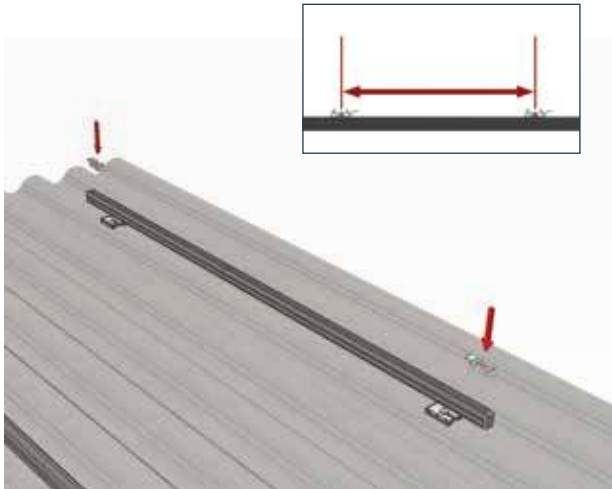

Another calculation method can be; the exact vertical interior space between the IP fix. This is measured per panel from the outermost point of the spring of the underlying IP-fix to the starting point of the IP-fix above. This is the size of the solar panel +/- 67 mm.

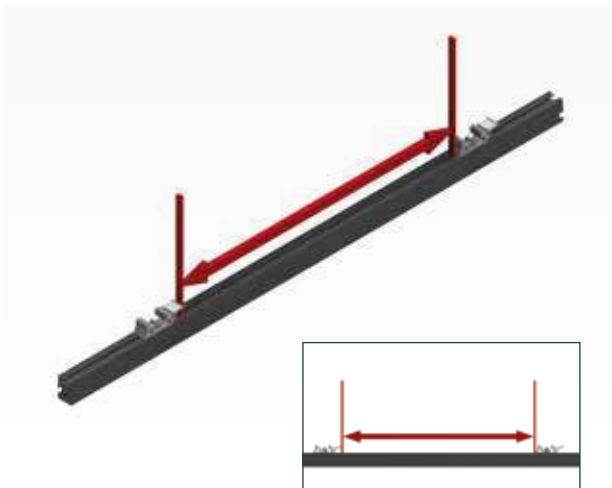

Secure the IP-fix in the correct position with the metal spring pointing upwards. For mounting the IP-fix, the hammer head bolts are used, which are placed in the groove of the profile and tightened clockwise with a flare nut. The head of the bolt must be properly seated in the groove after tightening with the groove in the head vertical.

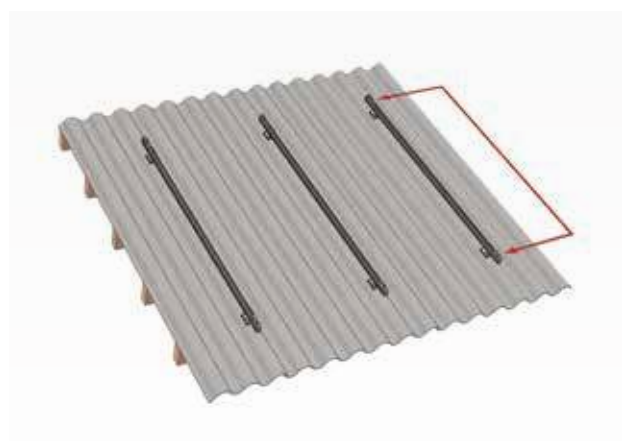
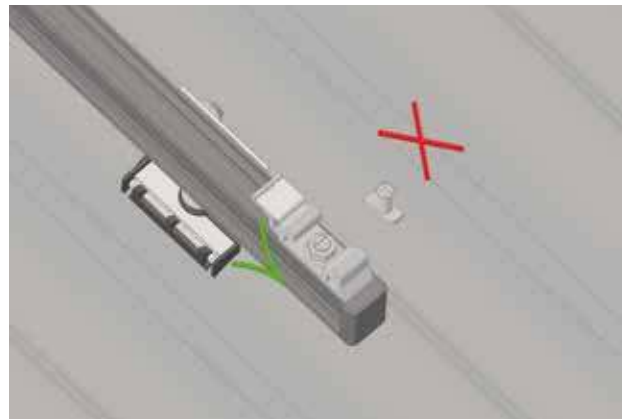

Step 4. Click IP insert profiles

When all IP-fix are mounted, the horizontal IP insert profiles can easily be clicked into place from top to bottom with the wider part of the front always pointing downwards.

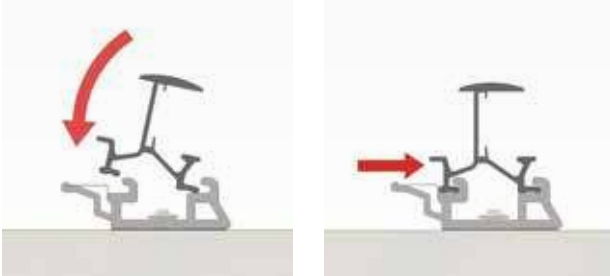

Prevent the rails from sliding due to heat or cold by securing only 1 (the middle) IP-fix per IP insert profile. Use the mounting tool to bend the IP insert profile, both left and right of the IP-fix, by moving downwards.



If the setup is wider than 6,2 meters, the IP insert profiles must be connected to each other with the IP-C insert profile connector. This is pushed in from the side halfway between the raised edges in the already mounted profile. This must then be secured on one side by making the correct movement upwards with the mounting tool (make sure that this lock is on the same side in all connections).



The next IP insert profile slides over the protruding part of the IP-C insert profile connector in such a way that a space of at least 5 mm between the two IP insert profiles remains open. This allows the IP insert profile to expand with heat and contract with cold. The system can continue to carry the load of the module without too much stress being applied.



Then the IP-E insert profile end caps can be installed. Slide it in from the side between the raised edges until it can go no further. Secure the IP-E insert profile end caps by moving the mounting tool upwards.

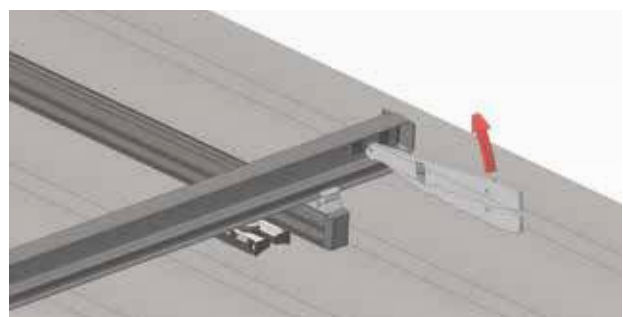
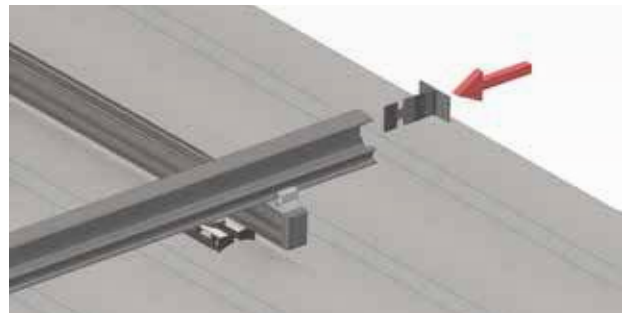

Step 5. Click cable bracket and opti bracket

Install cable bracket

- Click the cable bracket onto the IP insert profile by first hooking it onto the back and then clicking it upwards at the front.
- Slide the cables into the conductor, the 'plus' into one and the 'minus' into the other. Fasten with the ty-raps.

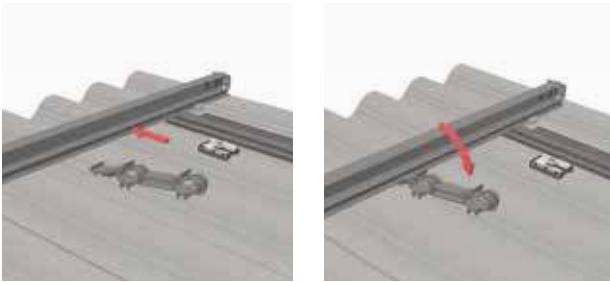

Install opti bracket

- Click the opti bracket onto the IP insert profile by first hooking it to the back and then clicking it upwards at the front.
- Click the optimizer onto the bracket.
- Connect the optimizer.

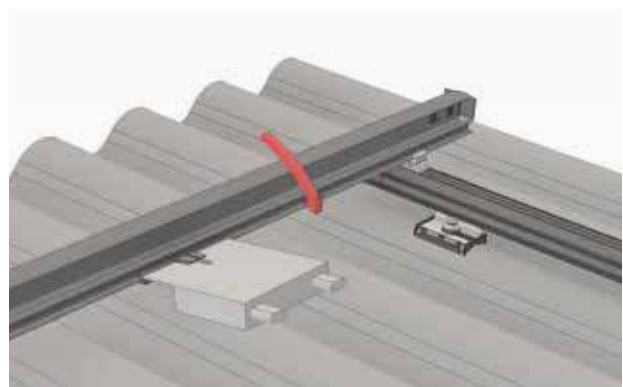
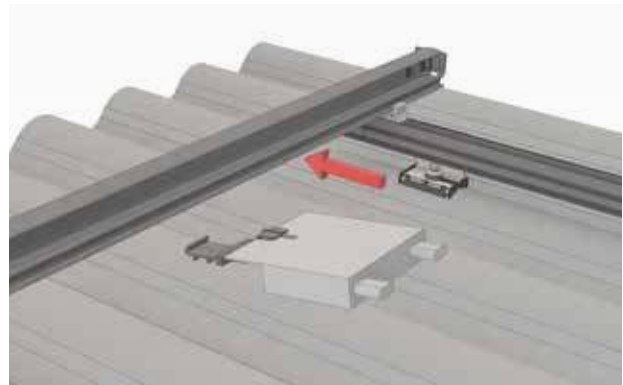
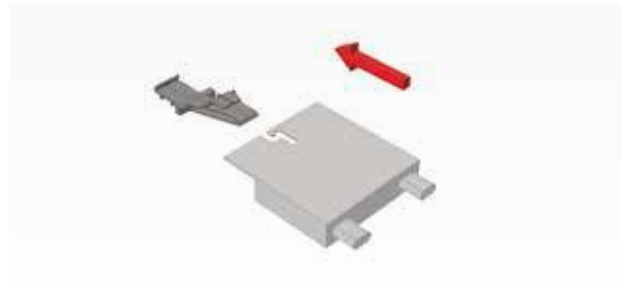

Step 6. Insert solar panels

When all IP insert profiles are attached, the solar panels can be inserted. Make sure that one power ground clamp is slid onto the IP insert profile to ground each solar panel.

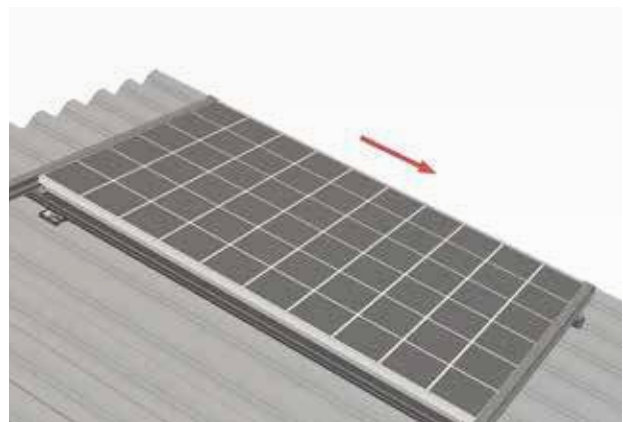
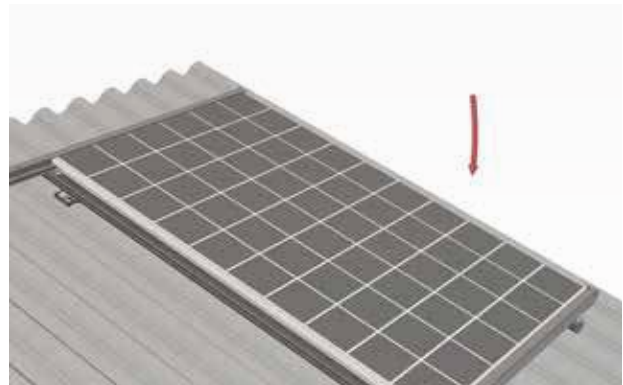
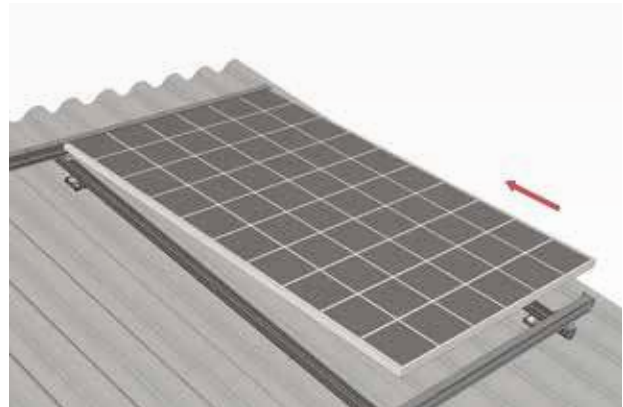

Insert the solar panel into the upper IP insert profile and then lower it into the lower part. Slide the module downwards so that the solar panel is located both above and below in the profile. This way they are held in place by gravity and therefore do not need to be secured further. If the angle is less than 10 degrees, place a rubber fuse at the top between the panels. The next panel can now be slid in and installed, right next to the panel that is already there.



Wognumsebuurt 10, B.0.1.
1817 BH Alkmaar
The Netherlands
+31(0)850 446 941
imscustomersupport@ims-solar.com
www.ims-solar.com